

# Double block valve Item 2012



Double block valve outside screw maintenance free with bellows in nodular cast iron EN-GJS-400-18-LT, series PN 16

## Main standard features

- Rise limiter (available on request)
- Lubricator
- Stop screw
- Opening index with anti-rotation function
- Backseat
- Rotating disc
- Pressed seats

## Application

Heat transfer systems, thermal power stations, industrial boilers and tanks, district heating plants, diathermic oil installations, etc.

## Suitable for

Hot water and/or overheated water, steam, air, diathermic fluids, etc.

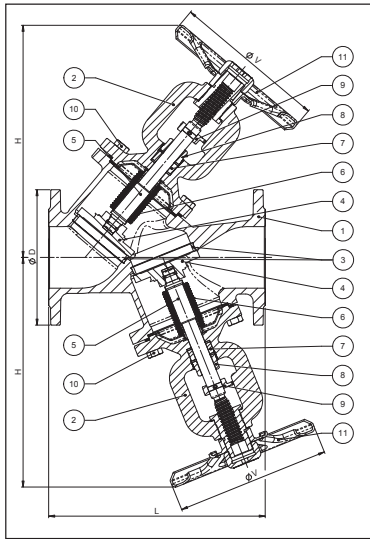
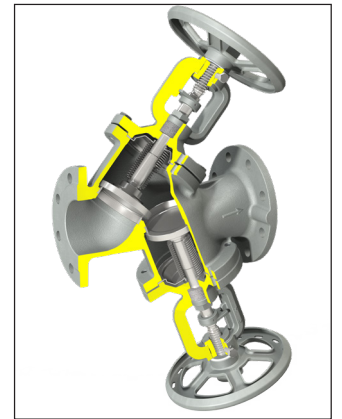

## Materials

POS.	Components	Material
1	Body	Nodular cast iron EN-GJS-400-18-LT
2	Yoke	Nodular cast iron EN-GJS-400-18-LT
3	Seats	Stainless steel 1.4021
4	Disc	Stainless steel 1.4021
5	Stem	Stainless steel 1.4021
6	Bellows	Stainless steel 1.4301
7	Packing	Graphite
8	Gland	Carbon Steel
9	Stem Guide	Carbon Steel
10	Bolts	Carbon Steel 8.8
11	Handwheel	Pressed Steel

## Size

DN	D	L	H	V
	[mm]	[mm]	[mm]	[mm]
40	150	200	241	150
50	165	230	247,5	150
65	185	290	314	200
80	200	310	323	200
100	220	350	377	250
125	250	400	416	300
150	285	480	478	350

## Options

On request is possible to make a "BLEED PORT" Ø 1/4"

On request available also isolation valve (according to the working conditions)

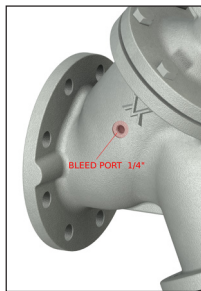

## Working conditions

Temperature [°C]	-10/+120	150	200	250	350	350
Pressure [bar]	16	15,5	14,7	13,9	12,8	11,2

## Manufacturing variations

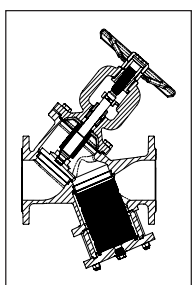

VALVE + STRAINER  
(Item 64 + Item 266)

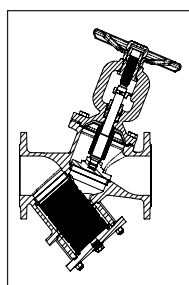

STRAINER + VALVE  
(Item 266 + Item 64)

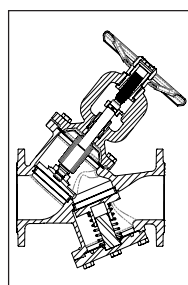

VALVE + CHECK  
(Item 64 + Item 56)

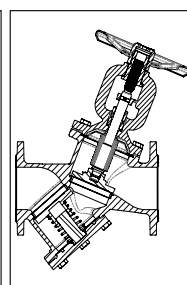

CHECK + VALVE  
(Item 56 + Item 64)

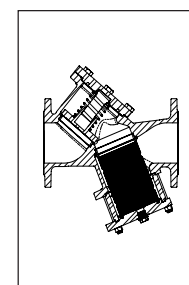

CHECK + STRAINER  
(Item 56 + Item 266)

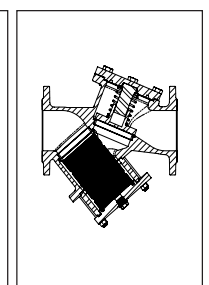

STRAINER + CHECK  
(Item 266 + Item 56)

MIVAL S.r.l. - Via Montecastello, 53 - 13037 Serravalle Sesia (VC)

Tel +39 0163452600 Fax +39 0163452650

www.mival.it - info@mival.it